

JAFTEX

EST. 1930

Free Spirit

Henry Glass & Co., Inc.

STUDIO fabrics
A Division Of JafTex Corporation
www.studiofabrics.net

Blank
QUILTING CORPORATION
the fabric of inspiration

3wishes
fabric

A.E. NATHAN COMPANY, INC.

Fabric
Editions, Inc.

Learn. Make. Love.

SIY Project



Sew It Yourself

The following project was created with fabric that your local retailer may no longer have available. You can re-create these projects by replacing the fabrics shown using the fabric key as a guide for similar colorations or styles.

PROJECT DISCLAIMER: Every effort has been made to ensure that all projects are error free. All the information is presented in good faith, however no warranty can be given not results guaranteed as we have no control over the execution of instructions. Therefore, we assume no responsibility for the use of this information or damages that may occur as a result. When errors are brought to our attention, we make every effort to correct and post a revision as soon as possible. We recommend that you test the project prior to cutting for kits. Finally, all free projects are intended to remain free to you and are not for resale.

SIY - Sew It Yourself™ is a trademark of JafTex Corporation

•••••
• A Free Project Sheet •
• NOT FOR RESALE •
•••••

Loads of Fun

Ironing Board Cover &
Laundry Bag



Ironing Board
Cover



Featuring fabrics from the **Loads of Fun** collection by **Chelsea Designworks** for **STUDIO·e·fabrics**

Ironing Board Cover Fabric Requirements

(A) 4882-93 2 yards

Laundry Bag Fabric Requirements

(A) 4881-93 1 2/3 yards
(B) 4885-99 1 1/3 yards
(C) 4883-93 2 3/4 yards
(D) 4890-3 1/4 yard

Additional Supplies Needed

- 2 yards of Muslin for lining
- Piece of cotton batting matching your Ironing Board Size.
- Drapery Cording, approximately 5-6 yards. *(You will need enough to go around the edge of the ironing board and ties.)*
- Piecing and sewing thread
- Quilting and sewing supplies

Project Information

Designed by Heidi Pridemore
Finished Ironing Board Cover Size:
Varies up to 64" long
Finished Laundry Bag Size:
40" x 18" x 18"
Skill Level: Intermediate

Please check our website for pattern updates before starting this project.

Fabrics in the Collection



Chalkboard Panel - Charcoal
4879P-99



Blocks - Gray/Taupe
4880-93



Washing Line - Gray/Taupe
4881-93



Laundry Icons - Gray/Taupe
4882-93



Cotton Plant - Gray
4883-93



Irons - Pewter
4884-90



Clothes Pegs - Taupe
4885-3



Clothes Pegs - Charcoal
4885-99



Shiplap - Pale Gray
4886-90



Safety Pins - Pigment White
4887-1W

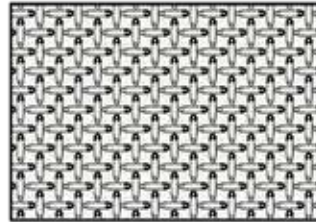

Safety Pins - Black
4887-9



Words - Black
4888-99



Care Symbols - Pigment White
4889-1W



Care Symbols - Black
4889-9



Plaid - Taupe
4890-3

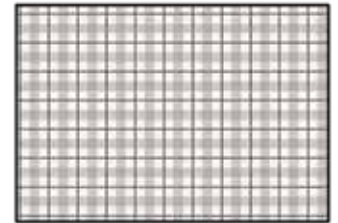

Plaid - Pewter
4890-9

Select Fabrics from
Peppered Cottons and Just Color!



Fog
Fog-47



Iron
1351-Iron

Ironing Board Cover Cutting

Cutting Instructions

Please note: All strips are cut across the width of fabric (WOF) from selvage to selvage edge unless otherwise noted.

WOF= Width of Fabric • LOF = Length of Fabric

Fabric A (4882-93 Laundry Icons - Gray/Taupe):

- See instructions to cut cover.

Muslin:

- See instructions to cut Lining.

Batting:

- See instructions to cut Pad.

Ironing Board Cover Sewing

Sew using a $\frac{1}{4}$ " seam allowance with right sides together (RST) unless otherwise indicated. Always press towards the darker fabric while assembling, unless otherwise noted by the arrows.

Ironing Board Cover Cutting Instructions

1. Using a large piece of paper, place the ironing board, top side down on the paper and trace the outside edge of the shape onto the paper to create the template of the top.
2. Measure the thickness of the ironing board and add 2" for the seam allowance to this measurement. This is the seam allowance amount that needs to be added to the original outline. Using a ruler, measure out from the drawn line in Step 1 the seam allowance amount and make tick marks every few inches. Once you have gone around the drawn line, connect the tick marks to draw the outer seam allowance line (Fig. 1).

3. Cut out the template on the outer line to make the template piece. Fold the template in half vertically and mark the grain line, Repeat horizontally to mark the second grain line.

4. Press the Fabric A and muslin fabrics to remove any wrinkles or fold lines.

5. Place the template on the wrong side of Fabric A and line up the grain line with the marks on the templates. Pin in place. Trace the template shape onto the fabric. Cut out the shape on the drawn line to make the outer cover. Repeat to cut out a piece of muslin for the lining (Fig. 5).

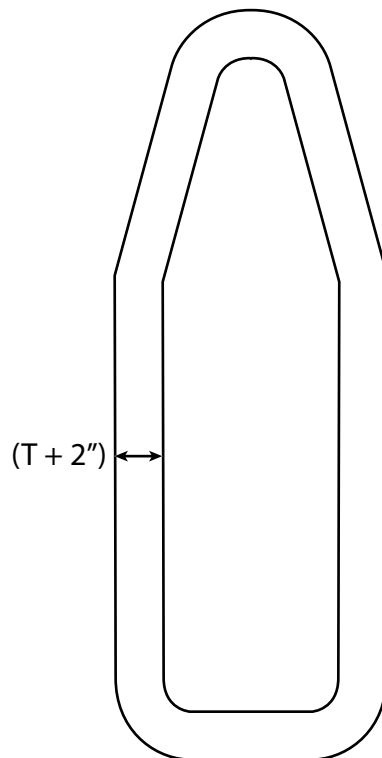

Fig. 1

Trace Ironing Board shape onto a large sheet of paper.

Measure thickness (T) of ironing board and add 2" to accommodate for the seam allowance.

Use a ruler to draw the seam allowance (T + 2") around the original ironing board shape.

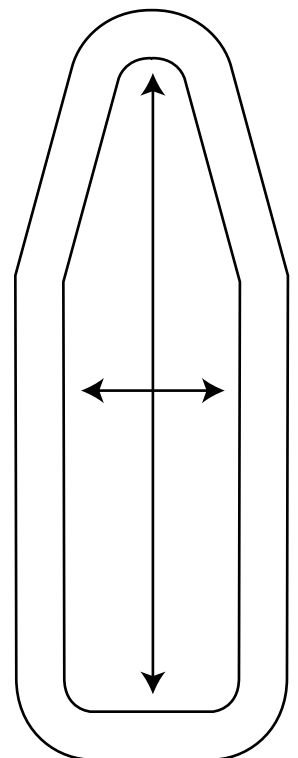

Fig. 2

6. To cut the padding, place the ironing board, top side down on the cotton batting and trace the outside edge of the shape onto the batting. Cut the batting on the drawn line to create the pad. If you desire a thicker pad, cut a second piece of cotton batting.

Ironing Board Cover Sewing

Instructions

7. Place the outer cover and lining, wrong sides together and pin. Zig zag stitch around the edges of both pieces to create one lined cover.

8. Sew a straight basting stitch, $\frac{1}{2}$ " from the outer edge on the cover (Fig. 3).

9. Using the basting stitch as a guide, press the edge of the cover under $\frac{1}{2}$ " and again another $\frac{1}{2}$ " to enclose the zig zag stitched edge of fabric. Work slowly and smooth out pleats while pressing the folds. **DO NOT SEW YET.**

10. Find the center of the short side on the cover. Measure $\frac{1}{2}$ " from the center and make a $\frac{1}{2}$ " mark on either side of the center on the inner fold of the fabric for the buttonholes (Fig. 4).

11. Using your favorite method, make a scant $\frac{1}{2}$ " buttonhole on each mark from Step 10. Open the buttonholes.

12. Refold and Press the outer edge, be sure to work in as much fullness as possible and pin the fold closed.

13. Sew as close to the inner folded edge as possible, to create a channel for the draw string cord. Make sure to sew over the first few stitches with the last stitches to re-enforce them.

Ironing Board Cover Assembly Instructions

14. To measure the drapery cord, lay on the ironing board, it will need to go around the outer edge of the ironing board and have enough for the ties. Cut to size.

15. Tie a knot in one end of the cord. Using a safety pin or a Bobkin, thread the cord through the ironing board cover going through the first buttonhole and coming out the second buttonhole.

16. Place the batting pad(s) on top of the ironing board.

17. Position the ironing board cover on top of the pads/ironing board, make sure it is centered and straight. Gently pull the drapery cord snug, adjusting the cover as needed. Once the cover is snug, tie the two ends of the cord to hold the cover in place.

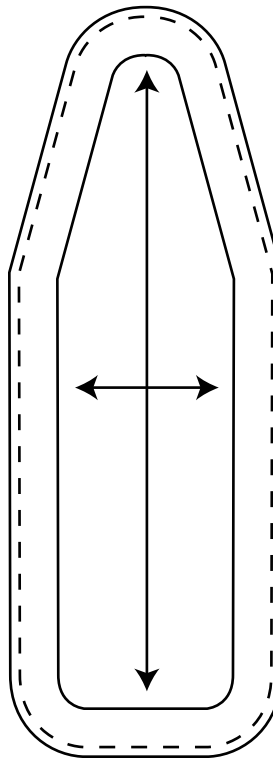

Fig. 3

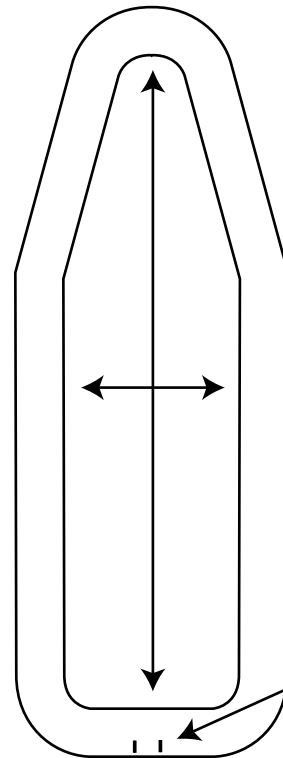

Fig. 4

Make two
buttonholes
for drawstring

Laundry Bag Cutting

Cutting Instructions

Please note: All strips are cut across the width of fabric (WOF) from selvage to selvage edge unless otherwise noted.

WOF= Width of Fabric • LOF = Length of Fabric.

Fabric A (4881-93 Washing Line - Gray/Taupe), cut:

- (2) 26 ½" x WOF strips. Sub-cut (4) 18 ½" x 26 ½"

Fabric B (4885-99 Clothes Pegs - Charcoal), cut:

- (2) 12 ½" x WOF strips. Sub-cut (4) 12 ½" x 18 ½"
- (1) 18 ½" square.

Fabric C (4883-93 Cotton Plant - Gray), cut

- (2) 38 ½" x WOF strips. Sub-cut (4) 18 ½" x 38 ½"
- (1) 18 ½" square.

Fabric D (4890-3 Plaid - Taupe), cut

- Cut (2) 2 ½" x WOF strips.

OPTIONAL: You can add stabilizer or fusible fleece to the bag front before assembly to add body to the bag or you can leave it without stabilizer to make it lightweight for traveling.

Laundry Bag Sewing

Sew using a ¼" seam allowance with right sides together (RST) unless otherwise indicated. Always press towards the darker fabric while assembling, unless otherwise noted by the arrows.

Laundry Bag Assembly Instructions

1. Sew (1) 18 ½" x 26 ½" Fabric A strip to the top of (1) 12 ½" x 18 ½" Fabric B strip to make (1) Side Panel (Fig. 5). Repeat to make (4) Side Panels total.

2. Measure and mark ¼" away from each edge of (1) 18 ½" Fabric B square.

3. Sew (1) side panel to the 18 ½" Fabric B square, starting and stopping at the ¼" marks. Repeat to add (3) remaining side panels to the 18 ½" Fabric B square to make the Outer Bag (Fig. 6).

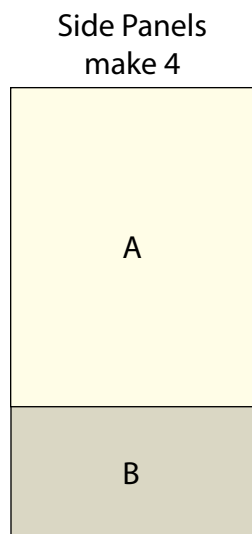

Fig. 5

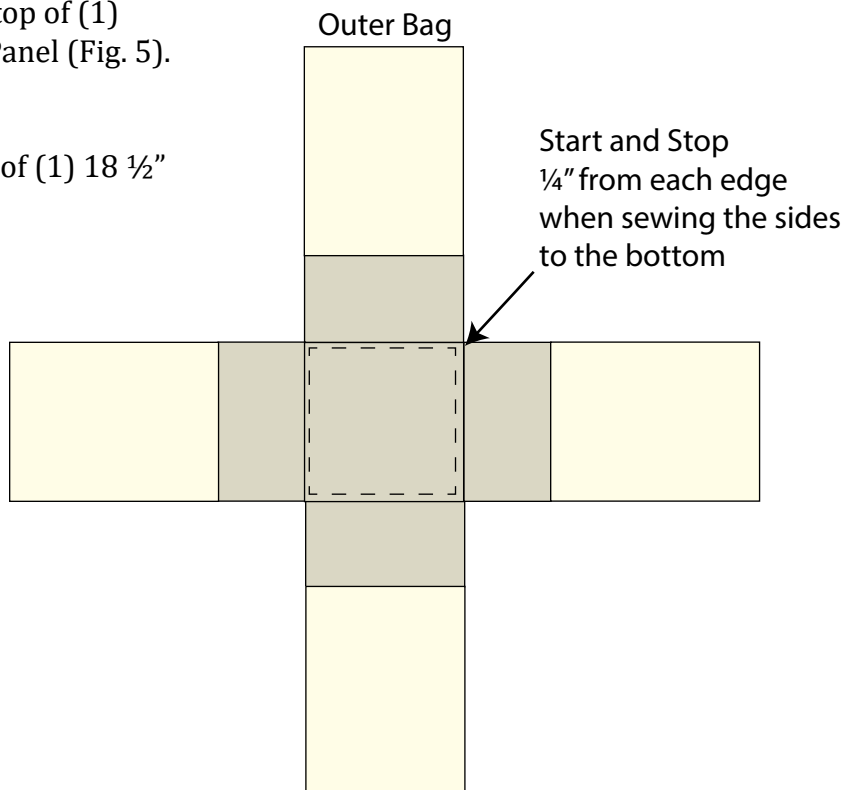

Fig. 6

4. Fold up (2) adjacent sides of the outer bag and pin, right sides together. Start sewing on the $\frac{1}{4}$ " mark at the bottom and sew up to the top edge to form one corner of the bag (Fig. 7). Repeat to create the (4) corners of the Outer Bag.
5. Repeat Steps 2-4 with (4) $18\frac{1}{2}$ " x $38\frac{1}{2}$ " Fabric C strips and (1) $18\frac{1}{2}$ " Fabric C square to make the lining bag. Leave a 4" to 5" opening in one side seam for turning later.
6. Measure down from the top edge of the lining $1\frac{1}{2}$ " and mark a line all the way around the bag top, on the wrong side of the fabric (Fig. 8).
7. Find the center of one side of the outer bag. Measure $\frac{1}{2}$ " from the center and make a $\frac{3}{4}$ " mark on either side of the center on the inner fold of the fabric for the buttonholes about 1" from the top edge.
8. Using your favorite method, make a scant $\frac{3}{4}$ " buttonhole on each mark from Step 7. Open the button holes (Fig. 9).
9. Slide the outer bag into the lining, right sides together (Fig. 10). Align the top edge of the outer bag and lining. Pin. Sew the two pieces together around the top edge.

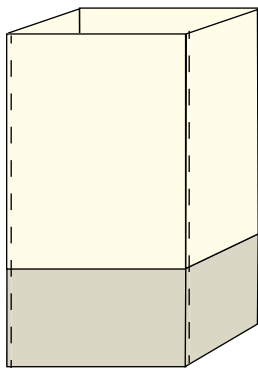

Fig. 7

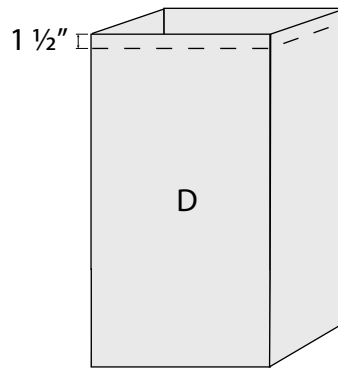

Fig. 8

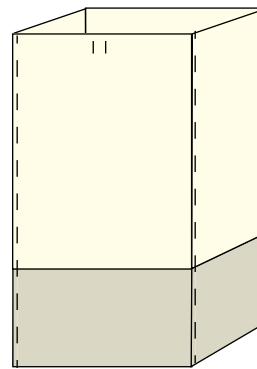

Fig. 9

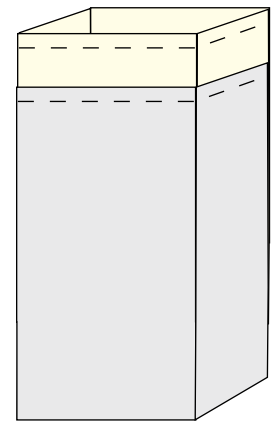

Fig. 10

10. Iron the top edge of the bag and lining to make sure they are flat on each side. Sew on the drawn line through both the lining and outer bag to create the drawstring channel. Turn the bag right side out through the opening in the lining. Stitch the opening closed.

11. Sew together (2) $2\frac{1}{2}$ " x WOF Fabric D strips, along the short end, using a 45 degree angle to make one long strip for the drawstring.

12. To make the drawstring, fold the Fabric D strip in half lengthwise and press (Fig. 11). Open the folded fabric and fold each long edge to the creased centerline and press (Fig. 12).

13. Fold the pressed fabric in half again and press to make one $\frac{5}{8}$ " wide strip (Fig. 13). Top stitch down both long sides $\frac{1}{8}$ " in from the edge to make the drawstring (Fig. 14).

14. Tie a knot in one end of the drawstring. Using a safety pin or a Bobkin, thread the drawstring through top of the bag going through the first buttonhole and coming out the second buttonhole. Tie a knot on the other end of the drawstring.

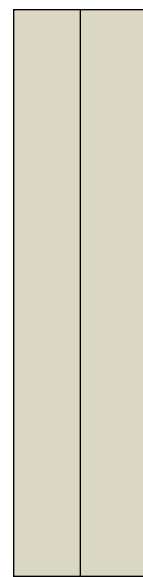

Fig. 11

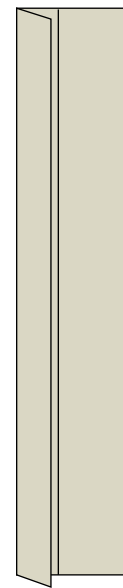

Fig. 12

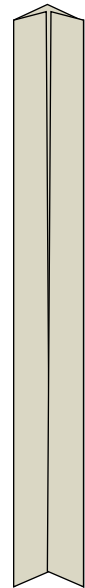

Fig. 11



Fig. 12

Every effort has been made to ensure that all projects are error free. All the information is presented in good faith, however no warranty can be given nor results guaranteed as we have no control over the execution of instructions. Therefore, we assume no responsibility for the use of this information or damages that may occur as a result. When errors are brought to our attention, we make every effort to correct and post a revision as soon as possible. Please make sure to check www.studioefabrics.net for pattern updates prior to starting the project. We also recommend that you test the project prior to cutting for kits. Finally, all free projects are intended to remain free to you and are **not for resale**.